

MINI TOWER MCL
COD: 5413-FH

Use:
food, inside, led
Installation:
Suspended
Fixing system:
Adjustable micrometric suspension system with steel cable L = 2100 mm
Body/structure:
Die-cast aluminium body
Coating:
Epoxy powder coating for inside use
Colour:
White
Optic/reflector:
Polycarbonate clear diffuser
Cable gland:
Nylon 66 cable locks
Control gear:
Integrated LED diodes ballast, stabilized output current 1050mA dc

Voltage: 220-240V 50/60Hz
Beam angle: Simmetric flood beam 40 Degrees
Insulation class: Insulation class 1
Weight: 2,700 kg
IP rating: 20
Glow wire: [650 °C]
Lamp included: Yes
Kind of led: Power LED
Lamp wattage: 37 W
Lamp luminous flux: 3450 lm
Colour temperature: 4000K
CRI: 90

Notes:
Suitable for fish

Review board: 07-02-2014

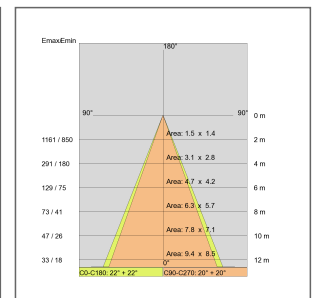
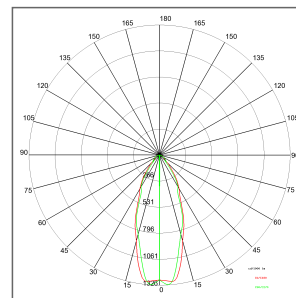

Lamp: 1 x LED +/- 37 W 3450 lm



IP 20 A+

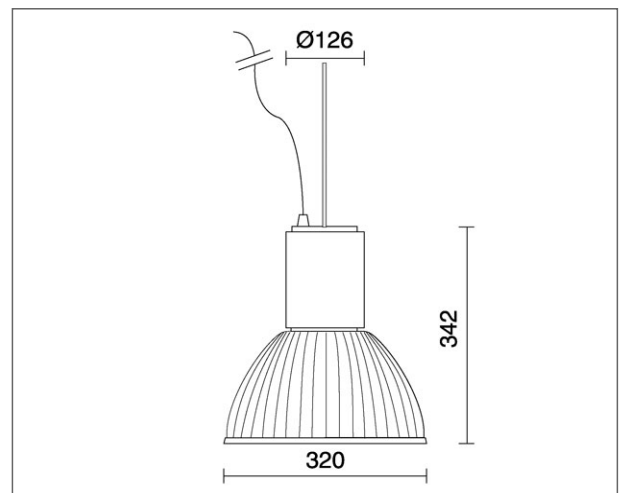

MINI TOWER MCL
COD: 5413-FH

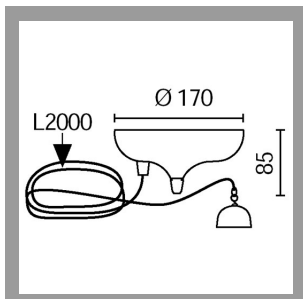

173
ROSONE CON FUNE DI
ACCIAIO

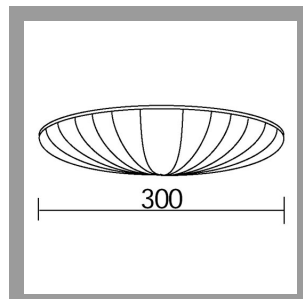

178
SCHERMO DI CHIUSURA

MINI TOWER MCL

COD: 5413-FH

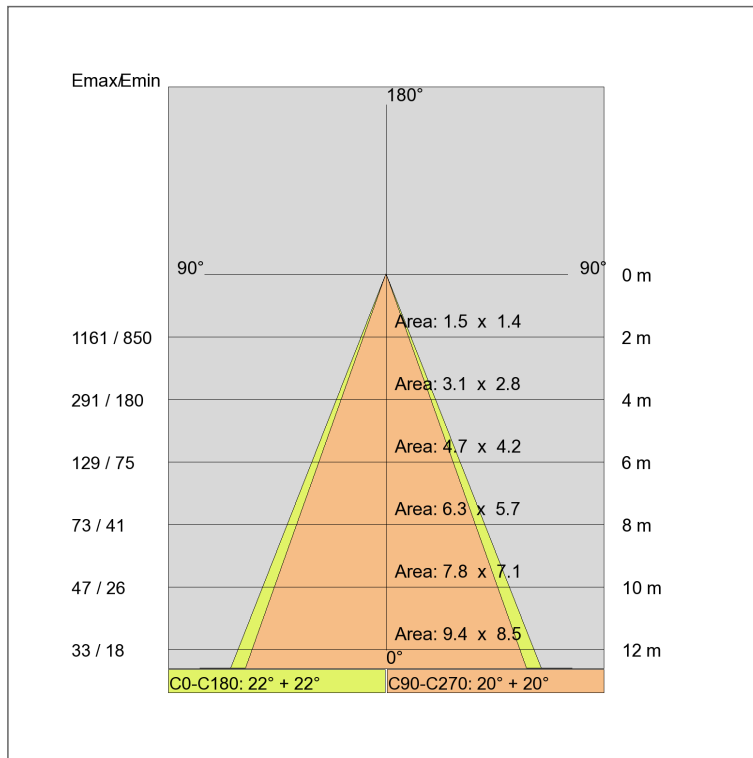
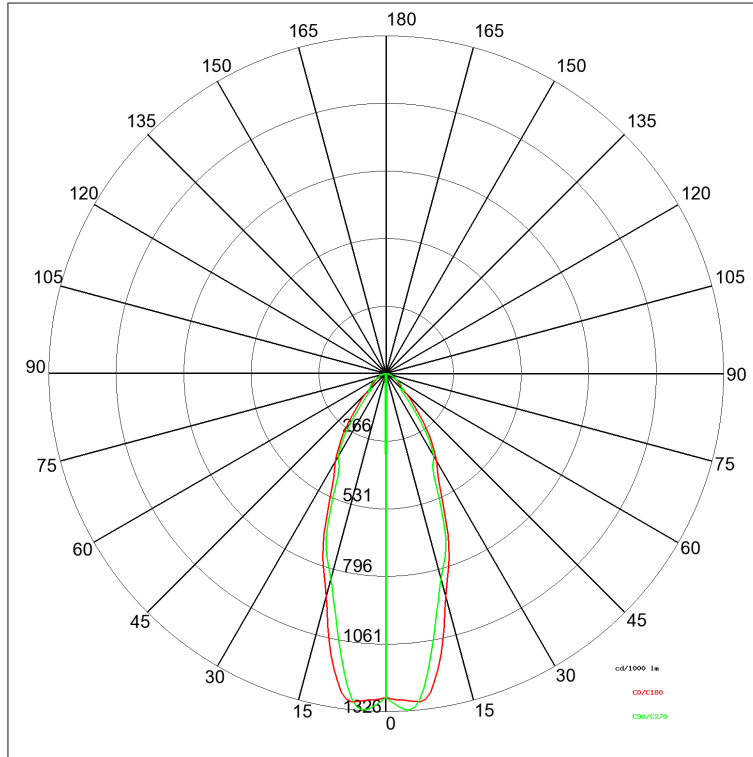

MINI TOWER MCL
COD: 5413-FH

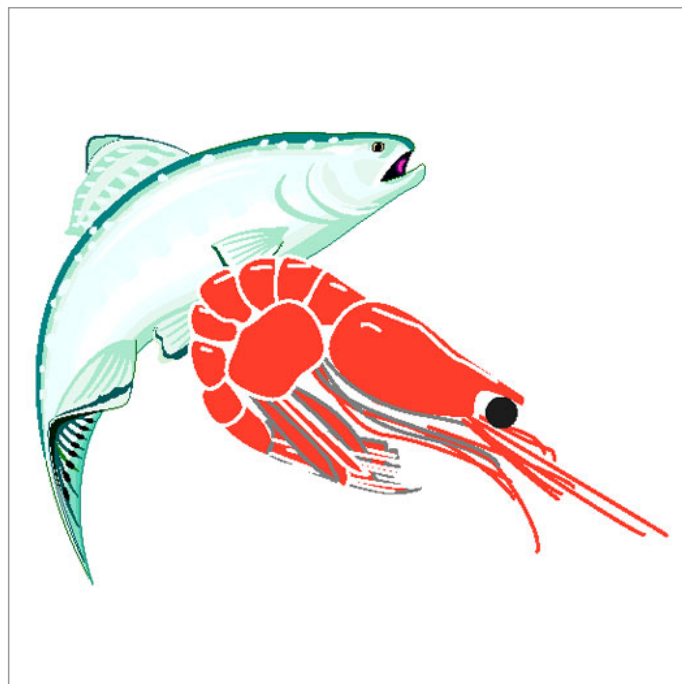

MINI TOWER MCL
COD: 5413-FH

